

# Ball Python Ghost/Hypo DNA Test

Version: 1.0

Release: August 2024  
©2023 by miniPCR Dx™

## CONTENTS

CONTENTS.....	1
OVERVIEW .....	2
TYPICAL RESULT .....	2
PROTOCOL AT GLANCE.....	3
KIT COMPONENTS .....	4
SUPPLIED IN KIT .....	4
SUPPLIED BY USER.....	5
BEFORE YOU START .....	8
LABORATORY GUIDELINES.....	8
CONTROLS.....	9
TUBE TYPES.....	10
MICROPIPETTING .....	11
PROGRAM THE miniPCR® OR OTHER THERMAL CYCLER .....	13
SHED COLLECTION .....	14
PROTOCOL.....	15
STEP 1. SETUP (10 MIN) .....	15
STEP 2. LYSIS (20 MIN).....	18
STEP 3. PCR (85 MIN).....	20
STEP 4. DNA GEL ELECTROPHORESIS AND VISUALIZATION (45 MIN) .....	22
EXPECTED RESULTS .....	25
EXAMPLE RESULTS .....	25
TROUBLESHOOTING.....	26

# Ball Python Ghost/Hypo DNA Test

## OVERVIEW

The gelPCR™ tests use PCR and DNA gel electrophoresis for genotyping purposes. The Ball Python Ghost/Hypo DNA Test is a gelPCR™ test to detect the mutation that results in the Ghost/Hypo phenotype in Ball Pythons (*Python regius*).

## TYPICAL RESULT

- Homozygous wild-type snakes will yield a single ~620 bp band
- Homozygous and Heterozygous Ghost/Hypo snakes will produce two bands (~620 and ~320 bp). For simplicity, we refer to the Ghost/Hypo allele as “Ghost” in the figure below.

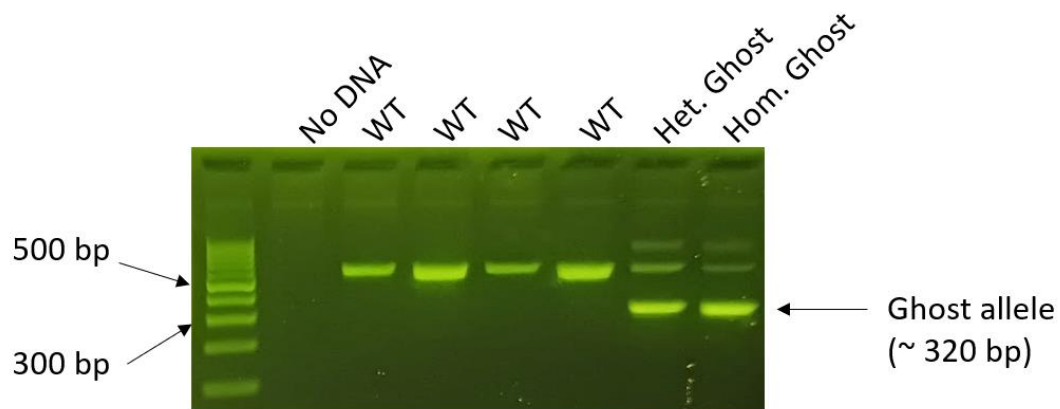

# Ball Python Ghost/Hypo DNA Test

## PROTOCOL AT GLANCE

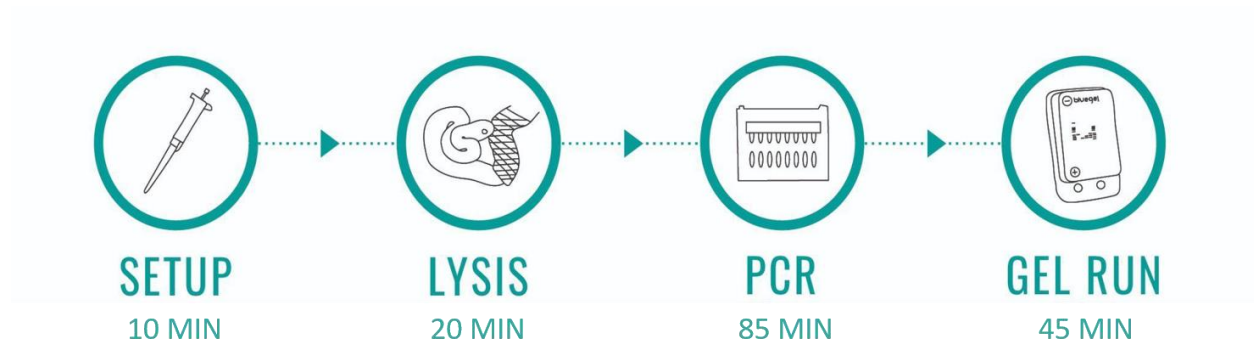

**For processing  
8 samples**



**Total  
time**



**Hands-on  
time**

## KIT COMPONENTS

The Ball Python Ghost/Hypo DNA Test has material for 38 tests, including samples and controls.

### SUPPLIED IN KIT

Reagents and Supplies	Quantity	Storage
<b>5X HOT Multiplex PCR Master Mix</b>	1 tube	Freezer
<b>1.2X Ghost Primers</b>	1 tube	Freezer
<b>gelPCR™ Control 1</b>	1 tube	Freezer
<b>DEB™ Extraction Buffer</b>	2 tubes	Freezer
<b>Fast DNA Ladder 1, 30 lanes</b>	1 tube	Freezer
<b>Strips of 8 PCR tubes</b>	10 strips	Room temp.

## SUPPLIED BY USER

Supplies available at [dx.minipcr.com](https://dx.minipcr.com)

### Equipment

These items will be a one-time purchase.

If you're starting your lab, we recommend the [gelPCR™ Bundles](#) (QP-2510-30 and QP-2510-40), which includes the equipment and consumables listed below, except for the optional centrifuge.

Alternatively, here is the list of all the recommended equipment. All are available at <https://dx.minipcr.com>.

Item	Quantity	Recommended product	Cat. Number
<b>Thermal cycler</b>	1	miniPCR® mini8X thermal cycler	QP-1000-08
		miniPCR® mini16X thermal cycler	QP-1016-16
<b>Gel electrophoresis and visualization system</b>	1	blueGel™ electrophoresis with built-in transilluminator	QP-1500-01
		GELATO™ electrophoresis and visualization system	QP-1600-01
<b>Micropipettes</b> • 1-10 µl • 2-20 µl • 20-200 µl • 100-1000 µl	1 each	1-10 µl H-style	QP-1001-05
		2-20 µl H-style	QP-1001-01
		20-200 µl H-style	QP-1001-03
		100-1000 µl H-style	QP-1002-02
<b>Microcentrifuge tube rack</b>	1	Microcentrifuge tube rack, 60-well	CM-1003-10
<b>PCR tube rack</b>	2	miniRack	CM-1003-04
<b>Microcentrifuge (optional)<sup>1</sup></b>	1	Gyro™ Microcentrifuge, fixed speed	QP-1800-01

<sup>1</sup> Microcentrifuging tubes will guarantee that the liquid collects at the bottom of the tubes, reducing contamination risk. Alternatively, flick tubes (see the "Liquid handling" section).

## Consumables

DNA gel electrophoresis reagents and plastic consumables will need to be refilled.

We recommend the Learning Lab Companion Kit (KT-1510-01) to refill DNA gel electrophoresis reagents and microcentrifuge tubes. One Learning Lab Companion Kit will provide enough material for running 38 reactions of the Lavender Chicken DNA Test.

Here is the complete list of all the necessary consumables.

Item	Quantity	Recommended product	Cat. Number
<b>Micropipette filter tips</b>	2 boxes each	1-10 µl	4AA75
		2-20 µl	4AA76
		20-200 µl	4AA77
		100-1000 µl	4AA78
<b>TBE Buffer</b>	Enough for making 600 ml – recommended if using blueGel™	TBE electrophoresis buffer, powder makes 600 ml	RG-1502-04
	Enough for making 3 L - recommended if using GELATO™	TBE electrophoresis buffer, powder makes 3 L	RG-1502-05
<b>DNA gel electrophoresis reagents</b>	Enough for preparing 8 small gels or 4 large gels.	SeeGreen™ All-in-One Agarose Tabs™, 8pcs	RG-1500-21
<b>Microcentrifuge tubes</b>	>10 tubes	Microtubes 1.5 ml	6AA02

## Other laboratory supplies

- Disposable laboratory gloves
- Bottle for preparing TBE buffer
- Container (e.g. flask or beaker) for preparing the gels
- Protective eyewear
- Lab coat
- Bottle or sprayer with 5% bleach (1 part bleach + 19 parts water)
- Permanent marker
- Disposable scalpels, blades, and/or tweezers
- Disposable toothpicks

## Ball Python Ghost/Hypo DNA Test

- Container with lid to dispose of tubes and tips
- Parchment paper or similar to samples on
- Filter paper for collecting blood samples
- Zip lock bags for collecting samples



## BEFORE YOU START

### LABORATORY GUIDELINES

**PCR is an extremely sensitive technology that can detect minute amounts of DNA. Always follow the practices outlined below to minimize the risk of contamination.**

- Set up your lab in an area that is removed from possible sources of snake DNA (e.g., away from the husbandry area).
- Keep each step of the process in separate rooms or areas and minimize traffic between them.
  1. Reagent setup area: for micropipetting kit reagents only, except for the positive control.
  2. Sampling area: for sampling the sheds and performing the lysis and PCR steps. Do not open tubes in this area after DNA has been amplified.
  3. DNA gel electrophoresis area: for running gels only.
- Dedicate a specific 2-20 µl micropipette and box of 20 µl filter tips for loading PCR samples into the gel. Never use this pipette and tips for preparing the PCR mix or for the DNA extraction step.
- Maintain a clean work area. Spray 5% bleach on work surfaces before and after every use.
- Prepare 5% bleach by 1 volume of household bleach to 19 volumes of distilled water.
- Change gloves between samples, or spray them with 5% bleach.
- Wear a clean lab coat when preparing the reagents.
- Discard materials such as tips, tubes, and gloves in a container that can be closed. Empty it often and clean it with 5% bleach.
- Keep all tubes closed except for the one that you are actively using.

**Failure to follow good laboratory practices can result in contamination that will invalidate results. A contaminated laboratory is difficult to clean up.**

## **CONTROLS**

### **Negative control (highly recommended)**

We strongly encourage you to run a negative control tube containing the DEB™ Extraction Buffer and PCR reagents but no DNA sample to check for possible contamination. We recommend running one negative control reaction with every PCR run. Presence of DNA bands in gel electrophoresis of the negative control is indicative of contamination and invalidates the results of all samples in the run.

### **Positive control (recommended if available)**

We encourage you to run a positive control reaction for every PCR run. The ideal sample for the positive control is DNA extracted from a known heterozygous or homozygous Ghost. This will help you recognize the two possible expected bands and clearly determine the genotype of the unknown samples. Check the section "Expected results" for more information.

### **gelPCR Control (recommended for new users)**

The gelPCR Control 1 reaction will generate a ~900 bp band. The presence of this band is indicative that the PCR master mix was prepared correctly and the PCR program was run as expected. We encourage you to run this reaction in parallel to your tests, especially when getting familiar with micropipetting technique and learning the PCR process.

## TUBE TYPES

Tube type	Picture	Description
Screw-cap reagent tube		Reagents for DNA extraction, PCR, and DNA gel electrophoresis.
1.5 ml microcentrifuge tubes		Used to prepare PCR mix. They are not included in the kit. Available at <a href="http://dx.minipcr.com">dx.minipcr.com</a>
PCR tubes		Used for the lysis and PCR steps. Included in the kit.

# Ball Python Ghost/Hypo DNA Test

## MICROPIPETTING

Good micropipetting skills are essential to run the test successfully. Practice with water or colored liquids before using the reagents in this kit.

We recommend to dedicate

- one 100-1000  $\mu$ l micropipette and one 20-200  $\mu$ l micropipette to the “reagent setup area” for preparing the reagents (see section “STEP 1: SETUP”)
- one 1-10  $\mu$ l micropipette to the “PCR area” for transferring the lysate and gelPCR™ Control 1 into the PCR mix (see section “STEP 3: PCR”)
- one 2-20  $\mu$ l micropipette for the DNA gel electrophoresis area for loading gels only (see section “STEP 4: DNA GEL ELECTROPHORESIS AND VISUALIZATION”).



Micropipetting Videotutorial

**Dedicating specific micropipettes and tip boxes to each area will reduce the contamination risk.**

Always select the right micropipette and tip based on the volume that you need to transfer according to the table below.

Volume range	Micropipette	Tips
1-10 $\mu$ l	 H10	 <b>10 <math>\mu</math>l micropipette filter tips</b>   Cambridge, Massachusetts, USA +1,781,990,8727 www.minipcr.com SKU: 4AA75 96 sterile tips, 0.5-10 $\mu$ l volume
2-20 $\mu$ l	 H20	 <b>20 <math>\mu</math>l micropipette filter tips</b>   Cambridge, Massachusetts, USA +1,781,990,8727 www.minipcr.com SKU: 4AA76 96 sterile tips, 2-20 $\mu$ l volume
20-200 $\mu$ l	 H200	 <b>200 <math>\mu</math>l micropipette filter tips</b>   Cambridge, Massachusetts, USA +1,781,990,8727 www.minipcr.com SKU: 4AA77 96 sterile tips, 20-200 $\mu$ l volume
100-1000 $\mu$ l	 H1000	 <b>1000 <math>\mu</math>l micropipette filter tips</b>   Cambridge, Massachusetts, USA +1,781,990,8727 www.minipcr.com SKU: 4AA78 96 sterile tips, 100-1000 $\mu$ l volume

## Ball Python Ghost/Hypo DNA Test

### LIQUID HANDLING

Use a microcentrifuge to collect the liquid at the bottom of the tubes. Alternatively, use a strong and quick flick of the wrist to collect the liquid at the bottom of the tube.

**To avoid contamination, make sure that all liquid is collected at the bottom of the tubes before opening them.**

Follow these steps to use the microcentrifuge:

1. Ensure that the contents of the tubes are fully defrosted.
2. Place the tubes in the rotor, making sure they are balanced as shown in the pictures. The tubes should have approximately the same amount of liquid in them. If needed, prepare a tube with water to balance the rotor. Refer to the manufacturer's instructions for details.
3. Spin for 5 seconds at 10,000 RPM.

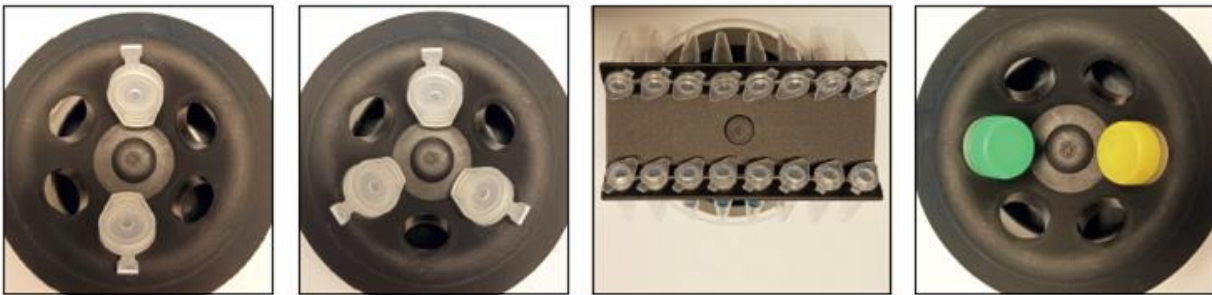

Examples of balanced microcentrifuges. Tubes match in size and contain the same volumes, making their weights comparable.

## PROGRAM THE miniPCR® OR OTHER THERMAL CYCLER

This is a one-time setup. The program will be saved in the software library and can be reused.



miniPCR®User's manual



Program the miniPCR®

### Shed DNA extraction

1. Click or tap on the (+) symbol on the top right corner of the app.
2. Select "Heat Block".
3. Enter information:
  - a. Name: "Shed DNA extraction" or name of your choice
  - b. 95 °C
  - c. 10 min
4. Click or tap "Save".

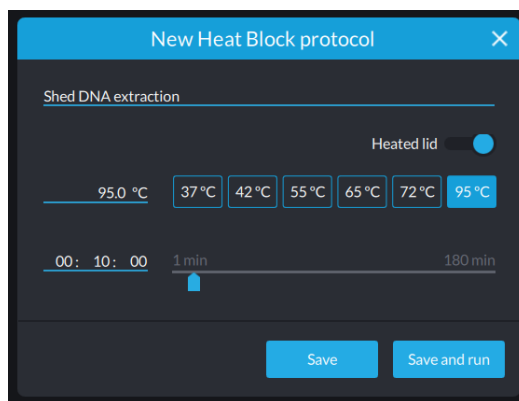

### Ball Python PCR 1

1. Click or tap on the (+) symbol.
2. Select "PCR".
3. Enter information:
  - a. Name: "Ball Python PCR 1" or name of your choice
  - b. Initial denaturation 95 °C, 720 sec
  - c. Denaturation 95 °C, 5 sec
  - d. Annealing 57 °C, 30 sec
  - e. Extension 72 °C, 45 sec
  - f. Number of cycles 34
  - g. Final extension 72 °C, 45 sec
5. Click or tap "Save".

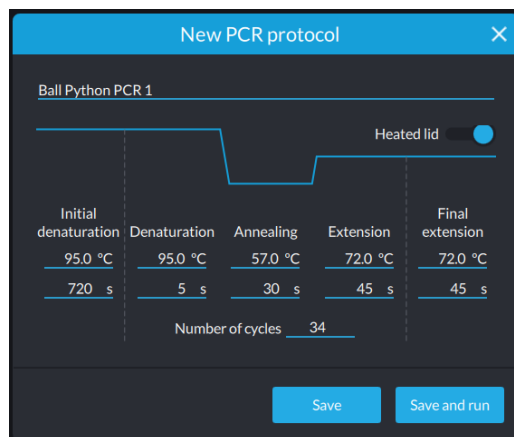

### SHED COLLECTION

- You will not need an entire shed for a test, a small piece is sufficient (you will use 1 dorsal scale per test, we recommend collecting at least 1 inch of shed).
- Wear gloves when collecting and handling the shed.
- Collect the shed and gently remove any particles and dirt.
- Fully dry it at room temperature for 1-2 days until all moisture has evaporated. Moisture can lead to rotten sheds that cannot be analyzed with this test.
- Once the shed is dry, store it in a labeled zip lock bag. Dry sheds will be stable for several months in the freezer. To use, remove from the freezer and wait five minutes before collecting the sample.
- If collecting sheds from different animals at the same time, make sure you clean your gloves with 5% bleach between samples and keep them in separate bags to avoid contamination.

## PROTOCOL

### STEP 1. SETUP (10 MIN)

First, you will prepare the reagents needed for the lysis and PCR.

Note, “complete mix” is the combination of 5X HOT Multiplex PCR Master Mix, and 1.2X Ghost Primers.

**Prepare the DEB™ Extraction Buffer and the complete mix in an area isolated from where the sample collection and amplification are performed to prevent contamination with snake DNA.**

1. Wear clean gloves.
2. Clean the surface of the reagent setup area with freshly prepared 5% bleach.
3. Prepare enough reagents to account for the number of shed samples that you are testing, the positive and negative controls, and the optional gelPCR control.

Example with gelPCR control

Shed samples	Negative control	Positive control	gelPCR control	Total tests
6	1	1	1	9

Example without gelPCR control

Shed samples	Negative control	Positive control	Total tests
6	1	1	8

4. Thaw the DEB™ DNA Extraction Buffer, the 5X HOT Multiplex PCR Master Mix, and 1.2X Ghost Primers. Ensure that the DEB™ DNA Extraction Buffer tube has no precipitates (solids) at the bottom. If present, shake well until the solution is homogeneous. Verify that all liquid is at the bottom of the tube before proceeding.
5. Label a strip of PCR tubes with your sample’s IDs. Mark the strip with a “DE” (as “DNA Extraction”). The tubes for the positive and negative controls should be as far apart from each other as possible (e.g., negative control in the first tube, positive control in the last tube). You will need one PCR tube per test.
6. Open the tubes and add **50 µl of DEB™ Extraction Buffer** to each tube using a 20-200 µl micropipette and the appropriate filter tip.



7. Close all the tubes. Tubes might be hard to close!



Example of a 20-200  $\mu$ l micropipette set to 50  $\mu$ l

- Label a second strip of PCR tubes. Mark the strip with a “P” (as “PCR”). The tubes for the negative and the positive controls should be as far apart from each other as possible. You will need one PCR tube per test.
- Prepare enough complete mix as indicated in the following table. Combine the volumes of 5X HOT Multiplex PCR Master Mix, and the 1.2X Ghost Primers in a 1.5 ml microcentrifuge tube.
  - “Number of total tests” is the sum of unknown shed samples, the negative control, the shed used as positive control, and the gelPCR control.
  - These calculations account for the loss of volume during pipetting. You may have a small amount of liquid left in the tube.
  - For other numbers of tests, multiply the volumes required for 1 sample by the total number of tests.

	Number of total tests	
	1	8
5X HOT Multiplex PCR Master Mix ( $\mu$ l)	5.5	44
1.2X Ghost Primers ( $\mu$ l)	22	176
<b>Total volume (<math>\mu</math>l)</b>	<b>27.5</b>	<b>220</b>

- Mix well but slowly by pipetting up and down at least six times, being careful not to introduce bubbles.

4. Add **23  $\mu$ l of the complete mix** to each PCR tube (use the strip designated for PCR labeled as “P”) using a 20-200  $\mu$ l micropipette and the appropriate filter tip.

**Remember to push the plunger only till the first stop when aspirating liquid.**

5. Close all tubes. Tap them lightly on the benchtop or briefly spin them in a microcentrifuge to collect all the liquid at the bottom of the tubes.

**Remember to bring the 5X HOT Multiplex PCR Master Mix, the 1.2X Ghost Primers back into the freezer. Once thawed, the DEB™ Extraction Buffer can be stored at room temperature.**

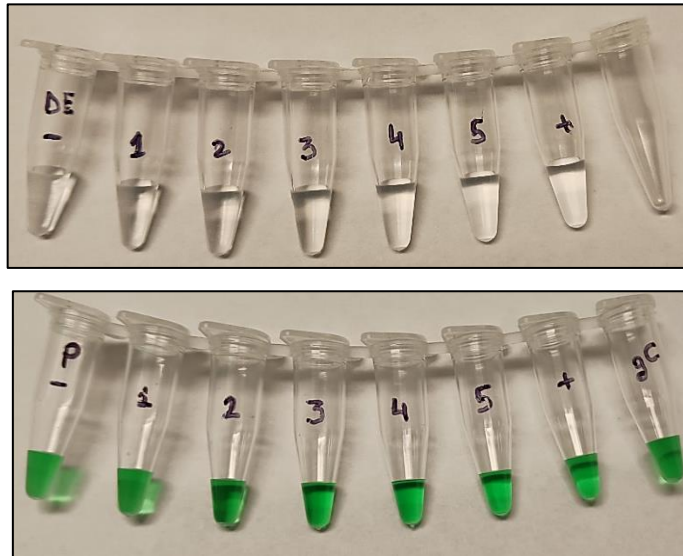

Example of tubes containing the DEB™ Extraction Buffer (top, transparent liquid) and the complete mix (bottom, green liquid).

The negative control is indicated with “-”, the positive with “+”, and the gelPCR control with “gC”.

### STEP 2. LYSIS (20 MIN)

10 minutes hands-on followed by a 10 minutes incubation.

You will now extract DNA from the sheds by adding scales to the tubes containing the DEB™ Extraction Buffer. Open only one tube at a time to avoid contamination.

1. Wear clean gloves and clean the surface of the sample collection area with freshly prepared 5% bleach.
2. Tap the tubes labeled as DE (transparent liquid). lightly on the benchtop or briefly spin them in a microcentrifuge to collect the liquid at the bottom.
3. Always keep the first tube (negative control) closed.
4. Place a piece of shed on a clean support (e.g., parchment paper) and cut a piece ~4 mm of diameter from the dorsal shed (about 1-4 scales), using a disposable scalpel or tweezer.

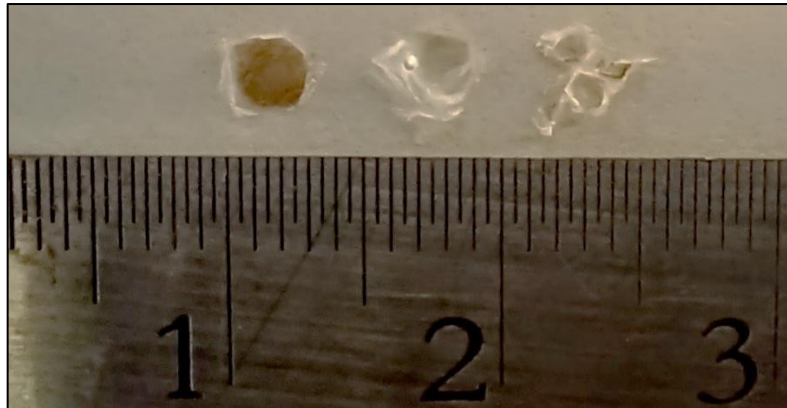

Example of samples of dorsal scales. Ruler in cm.

5. Open the corresponding tube and add the shed.
6. Discard the shed collection tool into the waste container. If the scalpel or the blade was protected with a cover, discard it in a sharps container without replacing the cover to avoid injuries.
7. **Make sure that the piece of shed is completely submerged in the liquid.** You can use a clean toothpick to push the scale into the liquid.
8. If used, discard the toothpick
9. Close the tube.
10. Put the shed back into its bag.
11. Dispose the parchment paper.
12. Clean the surface with 5% bleach.
13. Change gloves or clean them with 5% bleach.
14. Process the next samples following steps 4 to 14. If available, process the positive control last.
15. When all the samples are ready, make sure that all the caps are safely closed.

## Ball Python Ghost/Hypo DNA Test

16. Gently tap the tubes to collect the liquid at the bottom or briefly spin the strip in the microcentrifuge.
17. Load the samples into the miniPCR® or another thermal cycler. Close the lid.
18. Run the “Shed DNA extraction” program.

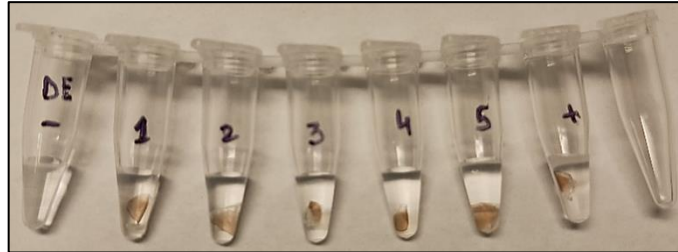

Example of tubes containing the shed samples for extracting DNA.

## Ball Python Ghost/Hypo DNA Test

### **STEP 3. PCR (85 MIN)**

5 minutes hands-on followed by 80 minutes PCR run.

In this step, you will add the extracted DNA (transparent liquid) to the complete mix (green liquid) and run the PCR. Open only one tube at a time to avoid possible contamination.

1. Wear clean gloves.
2. Position the strip containing the shed DNA (labeled “DE”, transparent liquid) on one miniRack and the strip containing the PCR mix (labeled ‘P’, green liquid) on another miniRack.
3. Open the first tube on both strips (negative control).
4. Using the dedicated 1-10  $\mu$ l micropipette and the appropriate filter tip, transfer 2  $\mu$ l from the lysis tube to the PCR mix tube
5. Discard the tip.
6. Close both tubes.



Example of a 1-10  $\mu$ l micropipette

7. Repeat steps 2-5 for all samples, making sure that you process one sample at the time.
8. Make sure that all tubes are closed.
9. If using gelPCR Control 1:
  - a. Make sure that gelPCR Control 1 has thawed.
  - b. Tap the tube gently on the bench or briefly spin it in a microcentrifuge to ensure that the liquid is at the bottom.
  - c. Open the screw-cap gelPCR Control 1 and also open the relative PCR tube.

## Ball Python Ghost/Hypo DNA Test

- d. Using a 1-10  $\mu$ l micropipette or a 2-20  $\mu$ l micropipette with a filter tip, transfer 2  $\mu$ l of gelPCR Control into the assigned tube.
- e. Discard the tip.
10. Close the gelPCR Control 1 and PCR tubes.
11. Flick the “P” strip (green liquid) and tap down, to make sure all the liquid is at the bottom. Alternatively, briefly spin in the microcentrifuge.
12. Load the samples into the miniPCR® or another thermal cycler.
13. Run the “Ball Python PCR 1” program.

**Remember to bring the gelPCR Control 1 back to the freezer.**

**Note:**

Once the PCR program has finished, samples can stay at room temperature overnight before running the DNA gel electrophoresis.

## STEP 4. DNA GEL ELECTROPHORESIS AND VISUALIZATION (45 MIN)

In this step you will prepare the setup for the DNA gel electrophoresis. You can cast the agarose gel and prepare the 1X TBE buffer while the “Ball Python PCR 1” is running.

1. Prepare the gel casting platform. Make sure that the comb is inserted.
2. If using SeeGreen™ All-in-One Agarose Tabs™ and blueGel™, follow the instructions for preparing a 2% gel.
  - a. For one blue gel, soak one tab in 20 ml of water and swirl for about 3 min, till the tab is fully dissolved.
  - b. Then, heat the solution until it is clear and all particles are dissolved (typically 30 - 60 seconds in a high-power microwave).
  - c. Pour the liquid into the casting platform.
  - d. Allow gel to solidify completely.
    - i. Gels will typically be ready in about 10 minutes.
    - ii. Gel is ready when cool and firm to the touch.

Alternatively, prepare a 2% Agarose gel in 1X TBE buffer with the appropriate amount of DNA staining dye.



How to pour a gel

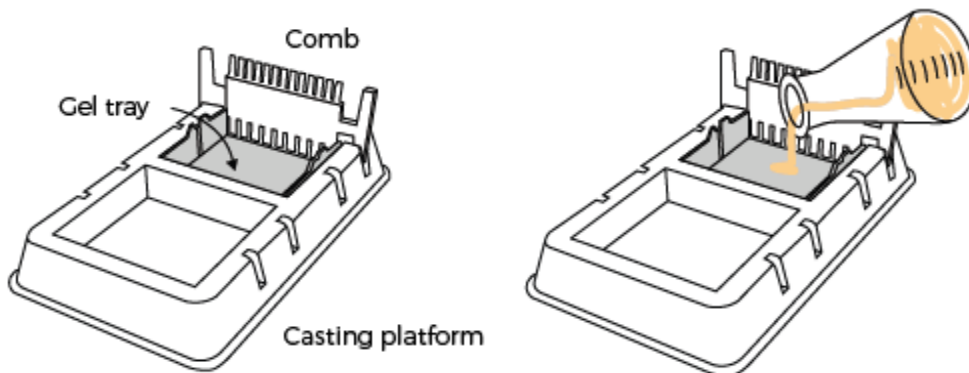

3. Once the gel is solid and the “Ball Python PCR 1” program is concluded, it is time to run the DNA gel electrophoresis.
4. Remove the comb by pulling firmly upwards and place the gel tray containing your gel in the buffer chamber. If using a blueGel™:
  - a. Ensure that the clear buffer chamber is inside the blueGel™ electrophoresis system.
  - b. The wells of the gel should be on the same side as the negative electrode, away from the power button.
5. Prepare the 1X TBE buffer by following the instructions on the container.
6. Add 1X TBE electrophoresis buffer to the chamber. If using a blueGel™, use 30 ml of 1X TBE buffer.
  - a. The buffer should just cover the gel and fill the wells.

- b. Ensure that there are no air bubbles in the wells (shake the gel gently if bubbles need to be dislodged).

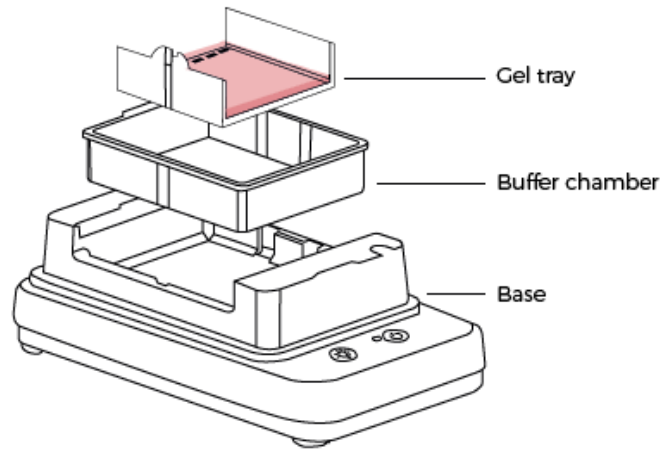

### Once the “Ball Python PCR 1” program is completed:

- Tap down or briefly centrifuge the tubes to make sure that the liquid (including possible condensation drops on the top of the tube) collects at the bottom before opening the tubes.
- Open the tubes only in the dedicated post-PCR area and use the dedicated micropipette and filter tips.
- Never open the tubes in the area where you prepare the PCR mix or collect shed DNA samples.
- Never use the micropipettes and the filter tips that you use for the pre-PCR steps for handling the post-PCR samples.

### These practices will reduce the risk of contamination.

7. Using the dedicated 2-20  $\mu$ l micropipette and 20  $\mu$ l filter tips, load 10  $\mu$ l of 100 bp DNA ladder, Load Ready™ in the first lane of the gel.

### Once thawed, the DNA ladder can be stored at room temperature.

8. Load 10  $\mu$ l of each PCR test in each well. Keep track of the order and change tips between samples.
9. Run the DNA gel electrophoresis. Specifically, if using a blueGel™:
  - a. Place the orange cover on the blueGel™ electrophoresis system.
  - b. To prevent fogging, make sure that ClearView™ spray has been evenly applied to the inside of the orange cover.

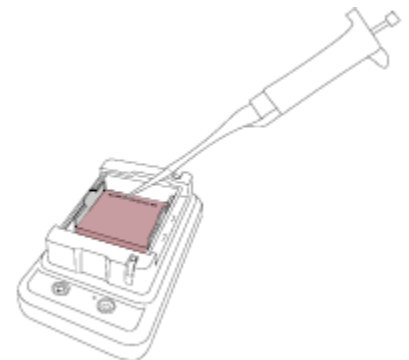



## Ball Python Ghost/Hypo DNA Test

- c. Match the positive and negative electrode signs on the orange lid with the corresponding positive and negative signs on the blue base.
  - d. The orange lid should sit flush with the blue base using little force.
  - e. Press the “Run” button. Check that the green light beside the power button remains illuminated.
10. Conduct electrophoresis for 30-45 minutes.

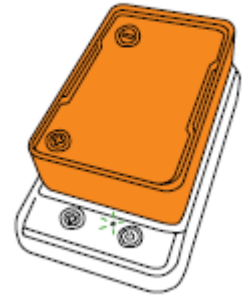

### Note

- Check gel every 15 minutes to monitor sample migration (follow instructions on step 11).
  - Longer electrophoresis times will result in better size resolution.
  - However, if run too long, small DNA fragments can run off the end of the gel or lose fluorescence.
11. Visualize the result using a transilluminator. If using a blueGel™
- a. Press the “light bulb” button to turn on the blueGel™ transilluminator.
  - b. For best viewing, dim lights or use Fold-a-View™ photo documentation hood with a smartphone camera.
  - c. If the image appears hazy, wipe off the inside of the orange cover and reapply ClearView™ spray.
  - d. Ensure that there is sufficient DNA band resolution in the 300-600 bp range of the 100bp DNA ladder, Load Ready™. Run the gel longer if needed to increase resolution.
12. Take a picture and document your result.
- a. Place Fold-a-View™ photo documentation hood on the blueGel™ electrophoresis system to take a picture with a smartphone or other digital camera.
  - b. Compare the bands from the DNA samples to the ladder to obtain size estimates and interpret the result (check “Expected results” section).

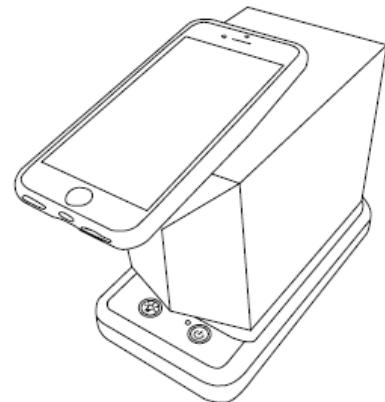

# Ball Python Ghost/Hypo DNA Test

## EXPECTED RESULTS

For simplicity, we refer to the Ghost/Hypo allele as “Ghost”.

- The negative control should show no bands. Bands in the negative control indicate that contamination occurred and that the results of the run are invalid.
- Homozygous wild-type snakes will yield a single ~620 bp band.
- Heterozygous Ghost snakes will produce two bands (~320 bp and ~620 bp, respectively).
- Homozygous Ghost snakes will produce two bands (~320 bp and ~620 bp, respectively). Occasionally, the upper band will be very faint or they will produce only one band at ~320 bp. These results are valid (see the “Troubleshooting” section below).
- gelPCR Control 1 will yield a ~900 bp band.

## EXAMPLE RESULTS

Lane 1: 100 bp DNA Ladder

Lane 2: negative control (no DNA)

Lanes 3-6: known homozygous wild type (WT)

Lane 7: known heterozygous Ghost

Lane 8: known homozygous Ghost

Lane 9: gelPCR Control 1

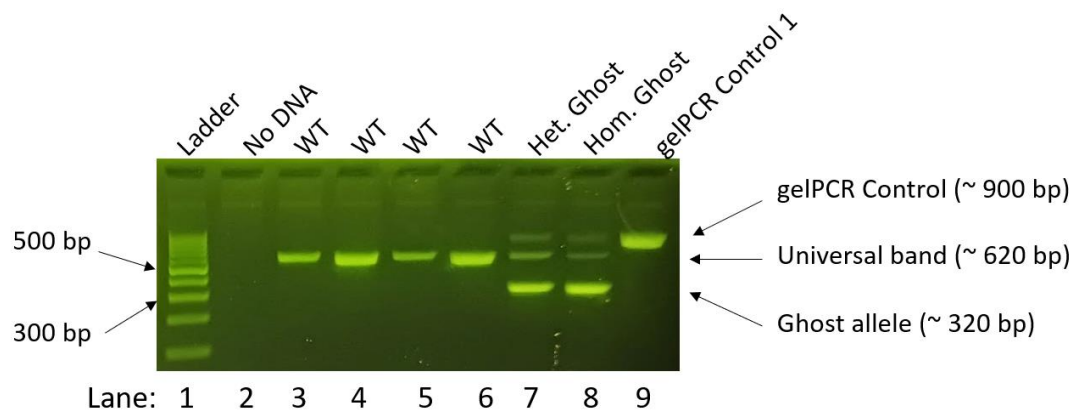

# Ball Python Ghost/Hypo DNA Test

## TROUBLESHOOTING

Occasionally, homozygous and heterozygous Ghost samples might show a very faint or absent upper band (~620 bp band). The result of the test is still valid as long as the Ghost specific band at ~320 bp is clearly visible.

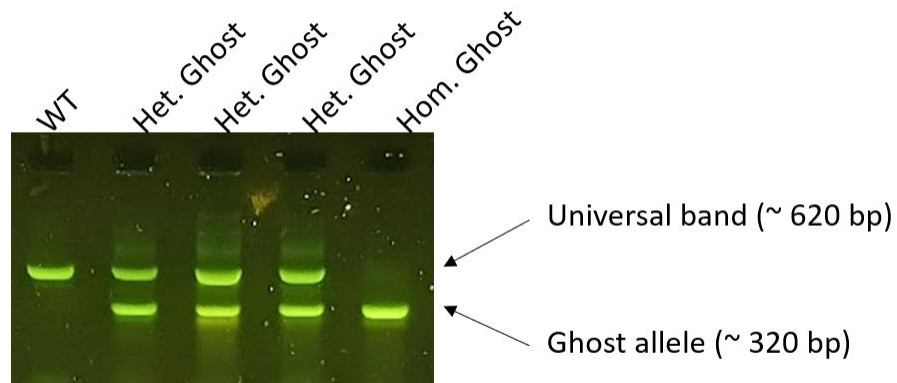
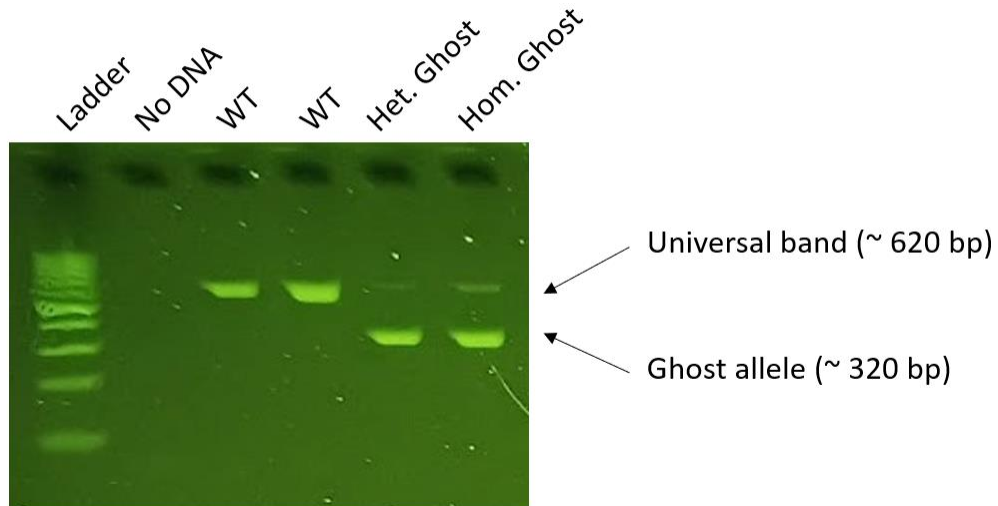

**Questions? Email [dx@minipcr.com](mailto:dx@minipcr.com) or call +1-781-990-8727 for technical support.**