

# Recessive White Chicken DNA Test

Version: 1.0

Release: February 2025  
©2025 by miniPCR Dx™

## CONTENTS

CONTENTS .....	1
OVERVIEW .....	2
PROTOCOL AT GLANCE .....	2
TYPICAL RESULT .....	3
KIT COMPONENTS .....	4
SUPPLIED IN KIT .....	4
SUPPLIED BY USER .....	5
BEFORE YOU START .....	8
LABORATORY GUIDELINES .....	8
CONTROLS.....	9
TUBE TYPES.....	10
MICROPIPETTING .....	11
LIQUID HANDLING .....	12
PROGRAM THE miniPCR® OR OTHER THERMAL CYCLER.....	13
BLOOD SAMPLE COLLECTION.....	14
PROTOCOL.....	15
STEP 1. SETUP (10 MIN) .....	15
STEP 2. LYSIS (20 MIN) .....	18
STEP 3. PCR (105 MIN).....	20
STEP 4. DNA GEL ELECTROPHORESIS AND VISUALIZATION (30 MIN).....	22
EXPECTED RESULTS .....	26
EXAMPLE RESULTS.....	26

# Recessive White Chicken DNA Test

## OVERVIEW

The gelPCR™ tests use PCR and DNA gel electrophoresis for genotyping purposes. The Recessive White Chicken DNA Test is a gelPCR™ test to determine the presence of the Recessive White allele in chicken (*Gallus gallus domesticus*) by PCR from blood samples. The Recessive White allele is also referred as C\*C allele, while the wild-type allele is called C\*N. Recessive White is an autosomal recessive trait that causes white plumage. Importantly, the test will allow you to distinguish between heterozygotes (C\*C/C\*N), homozygotes (C\*C/C\*C), and wild type chickens (C\*N/C\*N).

## PROTOCOL AT GLANCE

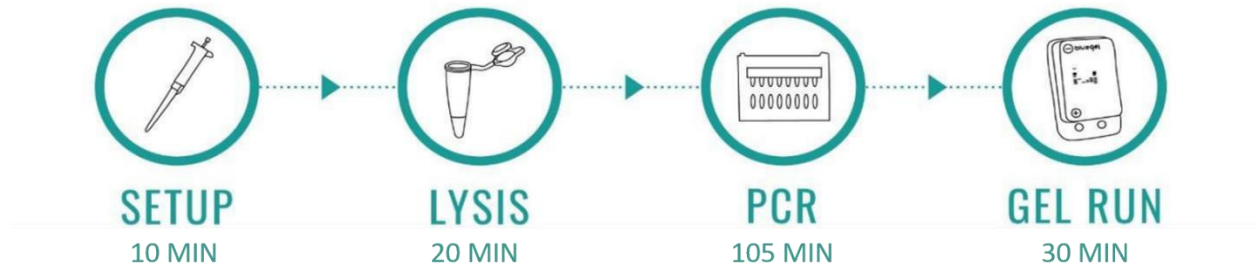

For processing  
8 samples



**Total  
Time**



**Hands-on  
Time**

# Recessive White Chicken DNA Test

## TYPICAL RESULT

- Homozygotes individuals carrying two copies of the Recessive White allele ( $C^*C/C^*C$ ) will show one band at ~350 bp
- Heterozygotes individuals carrying one copy of the Recessive White allele ( $C^*C/C^*N$ ) will show two bands: one band at ~350 bp and the other at ~480 bp
- Wild type individuals ( $C^*N/C^*N$ ) will show only one band at ~480 bp

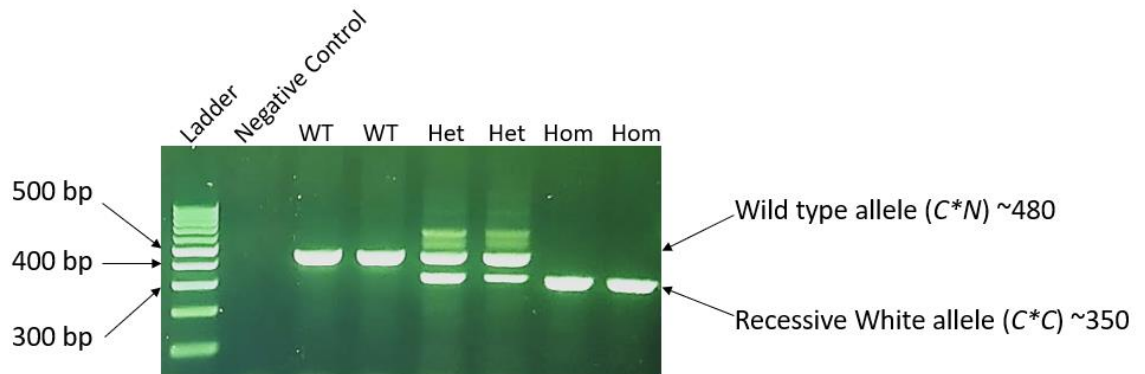

## KIT COMPONENTS

The Recessive White Chicken DNA Test has material for 38 tests (samples and controls).

### SUPPLIED IN KIT

Reagents and Supplies	Quantity	Storage
<b>DX PCR Master Mix</b>	1 tube	Freezer
<b>Rec. White Primers</b>	1 tube	Freezer
<b>gelPCR™ Control 1</b>	1 tube	Freezer
<b>DEB™ Extraction Buffer</b>	2 tubes	Freezer
<b>100 bp DNA ladder, Load Ready™, 20 lanes</b>	1 tube	Freezer
<b>Strips of 8 PCR tubes</b>	10 strips	Room temp.

# Recessive White Chicken DNA Test

## SUPPLIED BY USER

Supplies available at [dx.minipcr.com](http://dx.minipcr.com)

### Equipment

These items will be a one-time purchase.

For starting your lab, we recommend our **gelPCR™ Bundles** (QP-2510-30 and QP-2510-40), that contain the basic equipment and consumables to start testing.

Alternatively, here is the list of all the recommended equipment.

Item	Quantity	Recommended product	Cat. Number
<b>Thermal cycler</b>	1	miniPCR® mini8X thermal cycler	QP-1000-08
		miniPCR® mini16X thermal cycler	QP-1016-16
<b>Gel electrophoresis and visualization system</b>	1	blueGel™ electrophoresis with built-in transilluminator	QP-1500-01
		GELATO™ electrophoresis and visualization system	QP-1600-01
<b>Micropipettes</b> • 1-10 µl • 2-20 µl • 20-200 µl • 100-1000 µl	1 each	1-10 µl H-style	QP-1001-05
		2-20 µl H-style	QP-1001-01
		20-200 µl H-style	QP-1001-03
		100-1000 µl H-style	QP-1002-02
<b>Microcentrifuge tube rack</b>	1	Microcentrifuge tube rack, 60-well	CM-1003-10
<b>PCR tube rack</b>	2	miniRack	CM-1003-04
<b>Microcentrifuge (optional)<sup>1</sup></b>	1	Gyro™ Microcentrifuge, fixed speed	QP-1800-01

<sup>1</sup> Microcentrifuging tubes will guarantee that the liquid collects at the bottom of the tubes, reducing contamination risk. Alternatively, flick tubes (see the "Liquid handling" section).

## Recessive White Chicken DNA Test

### Consumables

DNA gel electrophoresis reagents and plastic consumables will need to be refilled.

We recommend the Learning Lab Companion Kit (KT-1510-01) to refill DNA gel electrophoresis reagents and microcentrifuge tubes. One Learning Lab Companion Kit will provide enough material for running 38 reactions of the Recessive White Chicken DNA Test.

Here is the complete list of all the necessary consumables.

Item	Quantity	Recommended product	Cat. Number
<b>Micropipette filter tips</b>	2 boxes each	1-10 µl	4AA75
		2-20 µl	4AA76
		20-200 µl	4AA77
		100-1000 µl	4AA78
<b>TBE Buffer</b>	Enough for making 600 ml – recommended if using blueGel™	TBE electrophoresis buffer, powder makes 600 ml	RG-1502-04
	Enough for making 3 L - recommended if using GELATO™	TBE electrophoresis buffer, powder makes 3 L	RG-1502-05
<b>DNA gel electrophoresis reagents</b>	Enough for preparing 8 small gels or 4 large gels.	SeeGreen™ All-in-One Agarose Tabs™, 8pcs	RG-1500-21
<b>Microcentrifuge tubes</b>	>10 tubes	Microtubes 1.5 ml	6AA02

### Other laboratory supplies

- Disposable laboratory gloves
- Bottle and DI water for preparing TBE buffer
- Container (e.g. flask or beaker) for preparing the gels
- Protective eyewear
- Lab coat
- Bottle or sprayer with 5% bleach (1 part bleach + 19 parts water)
- Permanent markers
- Disposable scalpels, blades, and/or tweezers
- Disposable toothpicks

## Recessive White Chicken DNA Test

- Containers with lid to dispose of tubes and tips
- Parchment paper or similar to place samples on
- Filter paper or printer/copy paper for collecting blood samples
- Zip lock bags for collecting samples



## BEFORE YOU START

### LABORATORY GUIDELINES

**PCR is an extremely sensitive technology that can detect minute amounts of DNA. Always follow the practices outlined below to minimize the risk of contamination.**

- Set up your lab in an area that is removed from possible sources of bird DNA (e.g., away from the husbandry area).
- Keep each step of the process in separate areas and avoid unnecessary trafficking between areas:
  1. Reagent setup area: for micropipetting kit reagents only (except for the gelPCR control).
  2. Sampling area: for collecting the samples and performing the lysis and PCR steps. Do not open tubes in this area after DNA has been amplified.
  3. DNA gel electrophoresis area: for running gels only.
- Dedicate a specific 2-20  $\mu$ l micropipette and box of 20  $\mu$ l filter tips for loading PCR samples into the gel. Never use this pipette and tips for preparing the PCR mix or for the DNA extraction step.
- Maintain a clean work area. Spray 5% bleach on work surfaces before and after every use.
- Prepare 5% bleach by 1 volume of household bleach to 19 volumes of distilled water.
- Change gloves between samples, or spray them with 5% bleach.
- Wear a clean lab coat when preparing the reagents.
- Discard materials such as tips, tubes, and gloves in a container that can be closed. Empty it often and clean it with 5% bleach.
- Keep all tubes closed except for the one that you are actively using.

**Failure to follow good laboratory practices can result in contamination that will invalidate results. A contaminated laboratory is difficult to clean up.**

## Recessive White Chicken DNA Test

### CONTROLS

#### **Negative control (strongly recommended)**

We strongly encourage you to run a negative control tube containing the PCR reagents but no DNA sample to check for possible contamination. We recommend running one negative control reaction per miniPCR® run. Presence of DNA bands in gel electrophoresis of the negative control is indicative of contamination and invalidates the results of the test batch.

#### **Positive control (recommended if available)**



We encourage you to run a positive control reaction for every miniPCR® run. The ideal sample for the positive control is DNA extracted from a known heterozygote. This will help you recognize the two possible expected bands and clearly determine the genotype of the unknown samples. Check the section "Expected results" for more information.

#### **gelPCR Control (recommended to new users)**

The gelPCR Control 1 reaction will generate a ~900 bp band. The presence of this band is indicative that the PCR master mix was prepared correctly and the PCR program was run as expected. We encourage you to run this reaction in parallel to your tests, especially when getting familiar with micropipetting technique and learning the PCR process.

# Recessive White Chicken DNA Test

## TUBE TYPES

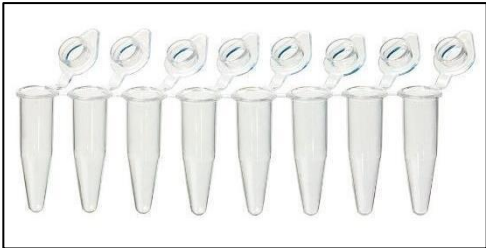
Tube type	Picture	Description
Screw-cap reagent tube		Reagents for DNA extraction, PCR, and DNA gel electrophoresis.
1.5 ml microcentrifuge tubes		Used to prepare PCR mix. They are not included in the kit. Available at <a href="http://dx.minipcr.com">dx.minipcr.com</a>
PCR tubes		Used for the lysis and PCR steps. Included in the kit.

# Recessive White Chicken DNA Test

## MICROPIPETTING

Good micropipetting skills are essential to run the test successfully. Practice with water or colored liquids before using the reagents in this kit.

We recommend to dedicate









- one 100-1000 µl micropipette and one 20-200 µl micropipette to the “reagent setup area” for preparing the reagents (see section “STEP 1: SETUP”)
- one 1-10 µl micropipette to the “PCR area” for transferring the lysate and gelPCR™ Control 1 into the PCR mix (see section “STEP 3: PCR”)
- one 2-20 µl micropipette for the DNA gel electrophoresis area for loading gels only (see section “STEP 4: DNA GEL ELECTROPHORESIS AND VISUALIZATION”).



Micropipetting Videotutorial

**Dedicating specific micropipettes and tip boxes to each area will reduce the contamination risk.**

Always select the right micropipette and tip based on the volume that you need to transfer according to the table below.

Volume range	Micropipette	Tips
1-10 µl	 H10	 10 µl micropipette filter tips 96 sterile tips, 0.5-10 µl volume
2-20 µl	 H20	 20 µl micropipette filter tips 96 sterile tips, 2-20 µl volume
20-200 µl	 H200	 200 µl micropipette filter tips 96 sterile tips, 20-200 µl volume
100-1000 µl	 H1000	 1000 µl micropipette filter tips 96 sterile tips, 100-1000 µl volume

## Recessive White Chicken DNA Test

### LIQUID HANDLING

Use a microcentrifuge to collect the liquid at the bottom of the tubes. Alternatively, use a strong and quick flick of the wrist to collect the liquid at the bottom of the tube.

**To avoid contamination, make sure that all liquid is collected at the bottom of the tubes before opening them.**

Follow these steps to use the microcentrifuge:

1. Ensure that the contents of the tubes are fully defrosted.
2. Place the tubes in the rotor, making sure they are balanced as shown in the pictures. The tubes should have approximately the same amount of liquid in them. If needed, prepare a tube with water to balance the rotor. Refer to the manufacturer's instructions for details.
3. Spin for 5 seconds at 10,000 RPM.

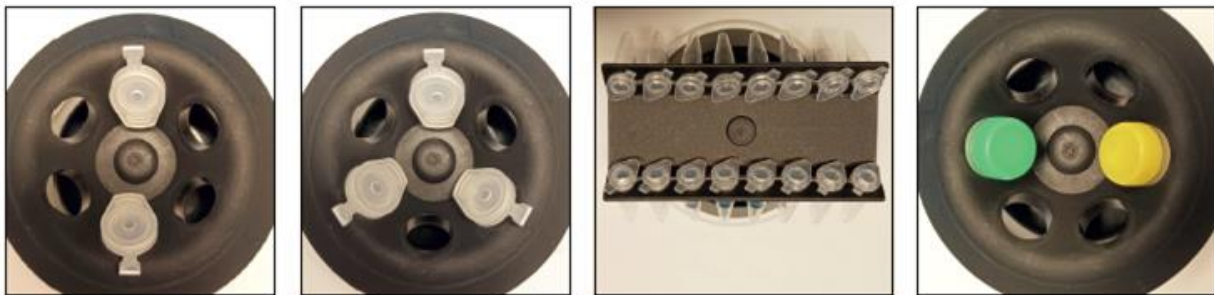

Examples of balanced microcentrifuges. Tubes match in size and contain the same volumes, making their weights comparable

# Recessive White Chicken DNA Test

## PROGRAM THE miniPCR® OR OTHER THERMAL CYCLER

This is a one-time setup. The program will be saved in the software library and can be reused.



miniPCR®User's manual



Program the miniPCR®

### DNA extraction

1. Click or tap on the (+) symbol on the top right corner of the app.
2. Select "Heat Block".
3. Enter information:
  - a. Name: "Avian DNA extraction" or name of your choice
  - b. 95 °C
  - c. 10 min
4. Click or tap "Save".

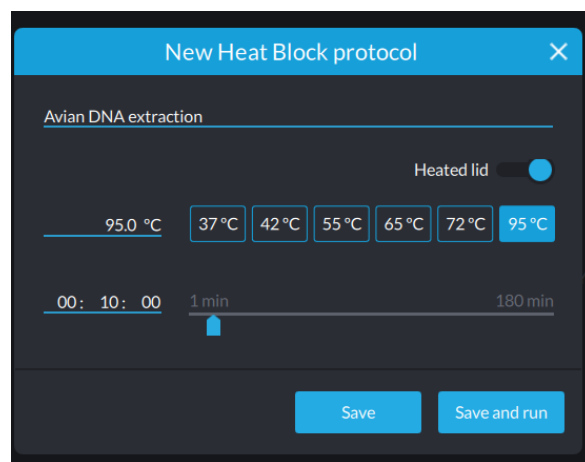

### Recessive White PCR

1. Click or tap on the (+) symbol.
2. Select "PCR".
3. Enter information:
  - a. Name: "Recessive White PCR" or name of your choice
  - b. Initial denaturation 95 °C, 720 sec
  - c. Denaturation 95 °C, 30 sec
  - d. Annealing 60 °C, 30 sec
  - e. Extension 72 °C, 30 sec
  - f. Number of cycles 32
  - g. Final extension 72 °C, 60 sec
5. Click or tap "Save".

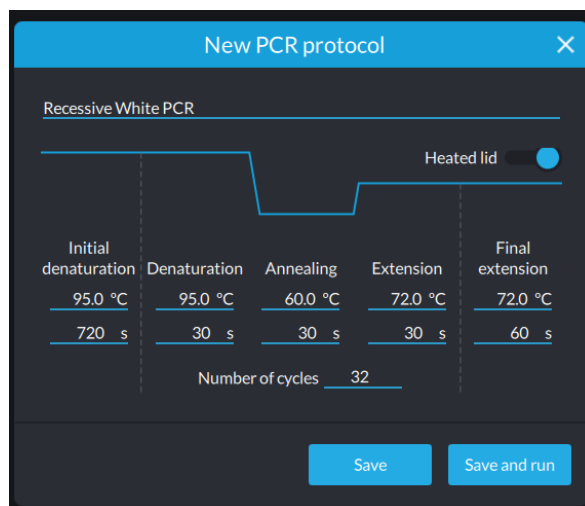

## **BLOOD SAMPLE COLLECTION**

- Cut small pieces (about 2 cm x 2 cm or 0.4inch x 0.4inch squares) of filter paper (e.g. filter paper for preparing coffee) or printer/copy paper.
- Pre label the filter paper by marking the sample ID on one corner.
- Draw blood from the animal. Blood can be collected from either *in-ovo* samples or from adult animals. We recommend consulting a vet for drawing blood from your animals.
- Spot a few drops of blood on the paper. Let it dry at room temperature and then close each sample into individual plastic zip lock bags.
- Make sure to change gloves or clean them with bleach in between samples.
- Samples are stable for 1 month at room temperature.
- You can run multiple tests from the same blood drop.

# Recessive White Chicken DNA Test

## PROTOCOL

### STEP 1. SETUP (10 MIN)

First, you will prepare the reagents needed for the lysis and PCR.

Note, “complete mix” is the combination of DX PCR Master Mix, and Rec. White Primers.

**Prepare the DEB™ Extraction Buffer and the PCR mix in an area isolated from where the sample collection and amplification are performed to prevent contamination with bird DNA.**

1. Wear clean gloves.
2. Clean the surface of the reagent setup area with freshly prepared 5% bleach.
3. Prepare enough reagents to account for the number of samples that you are testing, the positive and negative controls, and the optional gelPCR control.

Example with gelPCR control

Unknown samples	Negative control	Positive control	gelPCR control	Total tests
5	1	1	1	8

Example without gelPCR control

Unknown samples	Negative control	Positive control	Total tests
6	1	1	8

1. Thaw the DEB™ DNA Extraction Buffer, the DX PCR Master Mix, and Rec. White Primers at room temperature. Ensure that the DEB™ DNA Extraction Buffer tube has no precipitates (solids) at the bottom. If present, shake well until the solution is homogeneous. Verify that all liquid is at the bottom of the tube before proceeding.
2. Label a strip of PCR tubes with your sample’s IDs. Mark the strip with a “DE” (as “DNA Extraction”). The tubes for the positive and negative controls should be as far apart from each other as possible (e.g., negative control in the first tube, positive control in the last tube). You will need one PCR tube per test.
3. Open the tubes and add **50 µl of DEB™ Extraction Buffer** to each tube using a 20-200 µl micropipette and the appropriate filter tip.
4. Close all the tubes. Tubes might be hard to close!





Example of a 20-200 µl micropipette set to 50 µl

5. Label a second strip of PCR tubes. Mark the strip with a “P” (as “PCR”). The tubes for the negative and the positive controls should be as far apart from each other as possible. You will need one PCR tube per test.
6. Prepare enough complete mix as indicated in the following table. Combine the volumes of DX PCR Master Mix, and Rec. White Primers in a 1.5 ml tube.
  - “Number of total tests” refers to the sum of unknown samples, the negative control, the positive control, and the gelPCR control.
  - These calculations account for loss of volume during pipetting. You may have a small amount of liquid left in the tube.
  - For other numbers of tests, multiply the volumes required for 1 sample by the total number of tests.

	Number of total tests	
	1	8
DX PCR Master Mix (µl)	5.5	44
Rec. White Primers (µl)	22	176
<b>Total volume (µl)</b>	<b>27.5</b>	<b>220</b>

7. Mix well but slowly by pipetting up and down at least six times, being careful not to introduce bubbles.
8. Add **23 µl of the PCR mix** to each PCR tube (use the strip designated for PCR labeled as “P”) using a 20-200 µl micropipette and the appropriate filter tip.

**Remember to push the plunger only till the first stop when aspirating liquid.**

## Recessive White Chicken DNA Test

- Close all tubes. Tap them lightly on the benchtop or briefly spin them in a microcentrifuge to collect all the liquid at the bottom of the tubes.

**Remember to bring the DX PCR Master Mix and the Rec. White Primers back into the freezer. Once thawed, the DEB™ Extraction Buffer can be stored at room temperature.**

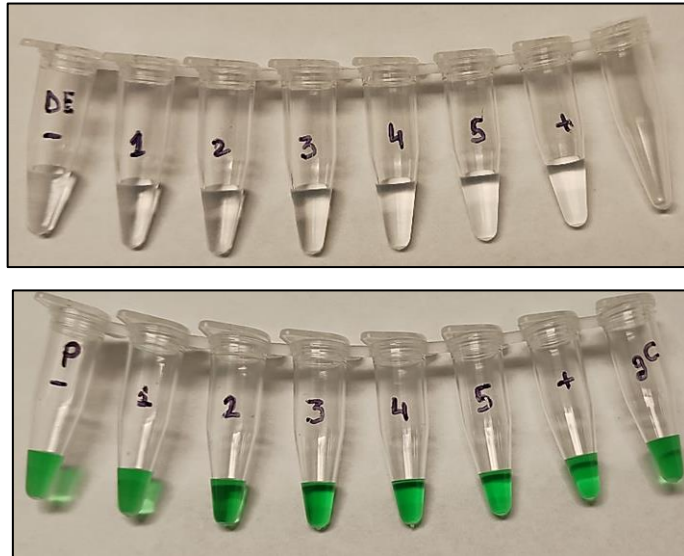

Example of tubes containing the DEB™ Extraction Buffer (top, transparent liquid) and the complete mix (bottom, green liquid).

The negative control is indicated with “-“, the positive with “+“, and the gelPCR control with “gC”.

## Recessive White Chicken DNA Test

### STEP 2. LYSIS (20 MIN)

10 minutes hands-on followed by a 10 minutes incubation.

1. Wear gloves and clean the surface of the “sample collection area” with freshly prepared 5% bleach.
2. Take the previously prepared PCR strip labeled as DE (“DNA Extraction”, transparent liquid). Tap the tubes lightly on the benchtop or briefly spin them in a microcentrifuge to collect the liquid at the bottom.
3. Always keep the first tube (negative control) closed.
4. Place the sample on a clean support (e.g., parchment paper) and take a clean disposable blade.
5. Cut a tiny piece of filtered paper with spotted blood (blood stain approximately 5 mm x 2 mm).
6. Open the corresponding tube and add the sample. Make sure that the blood stain on the paper is in contact with the buffer. If needed, use a clean toothpick to push the paper into the buffer.
7. Discard the toothpick and the disposable blade into the waste container. If the scalpel or the blade was protected with a cover, discard it in a sharps container without replacing the cover to avoid injuries.
8. Close the tube.
9. Put the sample back into its bag.
10. Dispose the parchment paper.
11. Clean the surface with 5% bleach.
12. Clean the gloves with 5% bleach or change gloves.
13. Process the next samples following steps 4-12. Process the positive control as last.



Example of blood sample

## Recessive White Chicken DNA Test

14. When all the samples are ready, make sure that all the caps are safely closed.
15. Gently tap the tubes to collect the liquid at the bottom or briefly spin the strip in the microcentrifuge.
16. Load the samples into the miniPCR® or another thermal cycler. Close the lid.
17. Run the “Avian DNA extraction” program until completion.

## Recessive White Chicken DNA Test

### STEP 3. PCR (105 MIN)

5 minutes hands-on followed by 100 minutes PCR run.

In this step, you will add the extracted DNA (transparent liquid) to the PCR mix (green liquid) and run the PCR. Open only one tube at a time to avoid possible contamination.

1. Position the strip containing the DNA samples (labeled “DE”, transparent liquid) on one miniRack and the strip containing the PCR mix (labeled ‘P’, green liquid) on another miniRack.
2. Open the first tube on both strips (negative control).
3. Using the dedicated 1-10  $\mu$ l micropipette and the appropriate filter tip, transfer 2  $\mu$ l from the lysis tube to the PCR mix tube.



Example of a 1-10  $\mu$ l micropipette set to 2  $\mu$ l

4. Discard the tip.
5. Close both tubes.
6. Repeat steps 2-5 for all samples, making sure that you process one sample at the time.
7. Make sure that all tubes are closed.
8. If using gelPCR Control 1:
  - a. Make sure that gelPCR Control 1 has thawed.
  - b. Tap the tube gently on the bench or briefly spin it in a microcentrifuge to ensure that the liquid is at the bottom.
  - c. Open the screw-cap gelPCR Control 1 and also open the relative PCR tube.
  - d. Using a 1-10  $\mu$ l micropipette or a 2-20  $\mu$ l micropipette with a filter tip, transfer 2  $\mu$ l of gelPCR Control 1 into the assigned tube.

## Recessive White Chicken DNA Test

- e. Discard the tip.
9. Close the gelPCR Control 1 and PCR tubes.
10. Flick the “P” strip (green liquid) and tap down, to make sure all the liquid is at the bottom. Alternatively, briefly spin in the microcentrifuge.
11. Load the samples into the miniPCR® or another thermal cycler.
12. Run the “Recessive White” program till completion.

**Remember to bring the gelPCR Control 1 back to the freezer.**

**Note:**

Once the PCR program has finished, samples can stay at room temperature overnight before running the DNA gel electrophoresis.

## STEP 4. DNA GEL ELECTROPHORESIS AND VISUALIZATION (30 MIN)

In this step you will prepare the setup for the DNA gel electrophoresis. You can cast the agarose gel and prepare the 1X TBE buffer while the “Recessive White PCR” is running.

1. Prepare the gel casting platform. Make sure that the comb is inserted.
2. If using SeeGreen™ All-in-One Agarose Tabs™ and blueGel™, follow the instructions for preparing a 2% gel.
  - a. For one blue gel, soak one tab in 20 ml of water and swirl for about 3 min, till the tab is fully dissolved.
  - b. Then, heat the solution until it is clear and all particles are dissolved (typically 30 - 60 seconds in a high-power microwave).
  - c. Pour the liquid into the casting platform.
  - d. Allow gel to solidify completely.
    - i. Gels will typically be ready in about 10 minutes.
    - ii. Gel is ready when cool and firm to the touch.

Alternatively, prepare a 2% Agarose gel in 1X TBE buffer with the appropriate amount of DNA staining dye.



How to pour a gel and prepare 1X TBE

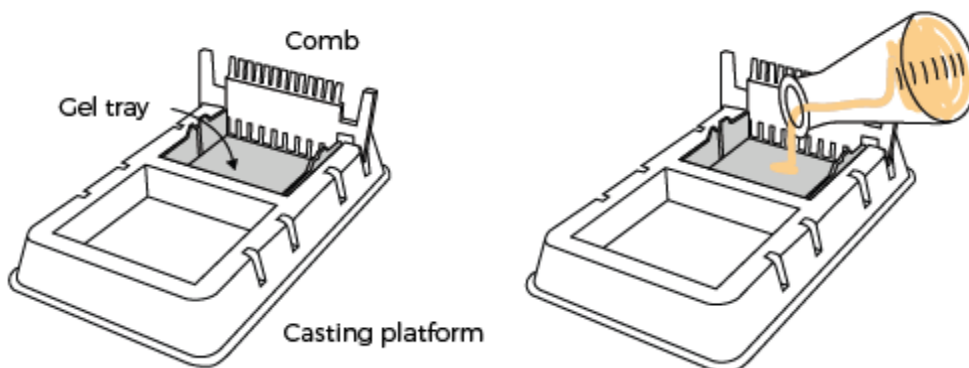

3. Once the gel is solid and the "Recessive White PCR" program is concluded, it is time to run the DNA gel electrophoresis.
4. Remove the comb by pulling firmly upwards and place the gel tray containing your gel in the buffer chamber. If using a blueGel™:
  - a. Ensure that the clear buffer chamber is inside the blueGel™ electrophoresis system.
  - b. The wells of the gel should be on the same side as the negative electrode, away from the power button.
5. Prepare the 1X TBE buffer by following the instructions on the container.

## Recessive White Chicken DNA Test

6. Add 1X TBE electrophoresis buffer to the chamber. If using a blueGel™, use 30 ml of 1X TBE buffer.
  - a. The buffer should just cover the gel and fill the wells.
  - b. Ensure that there are no air bubbles in the wells (shake the gel gently if bubbles need to be dislodged).

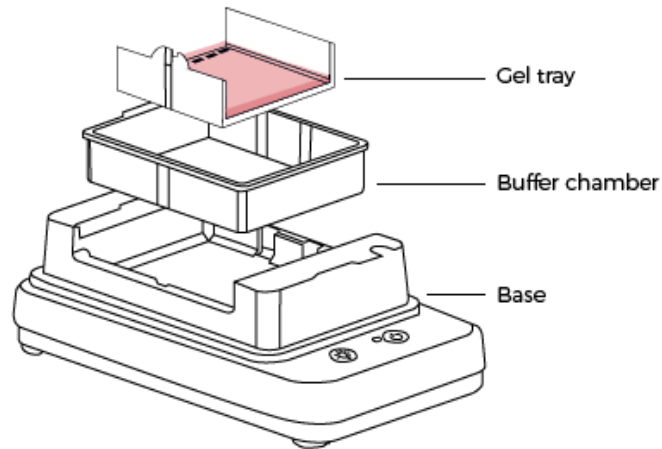

### Once the “Recessive White PCR” program is completed:

- Tap down or briefly centrifuge the tubes to make sure that the liquid (including possible condensation drops on the top of the tube) collects at the bottom before opening the tubes.
- Open the tubes only in the dedicated post-PCR area and use the dedicated micropipette and filter tips.
- Never open the tubes in the area where you prepare the PCR mix or collect the DNA samples.
- Never use the micropipettes and the filter tips that you use for the pre-PCR steps for handling the post-PCR samples.

### These practices will reduce the risk of contamination.

7. Using the dedicated 2-20  $\mu$ l micropipette and 20  $\mu$ l filter tips, load the 100 bp DNA ladder, Load Ready™ in the first lane of the gel.
  - a. If using the 8-wells comb, load 10  $\mu$ l
  - b. If using the 13-wells comb, load 7  $\mu$ l

### Once thawed, the DNA ladder can be stored at room temperature.



# Recessive White Chicken DNA Test

8. Load the PCR samples:
  - a. If using the 8-wells comb, load 10  $\mu$ l of each PCR test in each well. Keep track of the order and change tips between samples.
  - b. If using the 13-wells comb, load 7  $\mu$ l of each PCR test. Keep track of the order and change tips between samples.

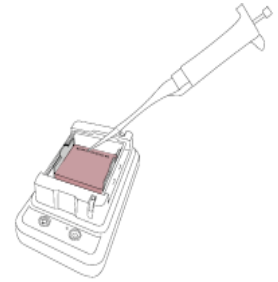

9. Run the DNA gel electrophoresis.

Specifically, if using a blueGel™:

- a. Place the orange cover on the blueGel™ electrophoresis system.
- b. To prevent fogging, make sure that ClearView™ spray has been evenly applied to the inside of the orange cover.
- c. Match the positive and negative electrode signs on the orange lid with the corresponding positive and negative signs on the blue base.
- d. The orange lid should sit flush with the blue base using little force.
- e. Press the “Run” button. Check that the green light beside the power button remains illuminated.



blueGel™ User's guide

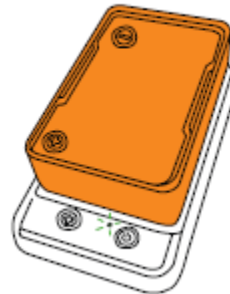

10. Conduct electrophoresis for 15-30 minutes. Check gel and take a picture every 15 minutes to monitor sample migration (follow instructions on step 11 and 12).

### Note

- Longer electrophoresis times will result in better size resolution.
- However, if run too long, small DNA fragments can run off the end of the gel or lose fluorescence.
- If using GELATO™ electrophoresis and visualization system, run DNA gel electrophoresis at 135 V and take a picture at 10 minutes and at 20 minutes. Please, refer to GELATO™ User's guide to operate the instrument.



GELATO™ User's guide

## Recessive White Chicken DNA Test

11. Visualize the result using a transilluminator. If using a blueGel™
  - a. Press the “light bulb” button to turn on the blueGel™ transilluminator.
  - b. For best viewing, dim lights or use the Fold-a-View™ photo documentation hood with a smartphone camera.
  - c. If the image appears hazy, wipe off the inside of the orange cover and reapply ClearView™ spray.
  - d. Ensure that there is sufficient DNA band resolution in the 200-500 bp range of the 100bp DNA ladder, Load Ready™. Run the gel longer if needed to increase resolution.
12. Take a picture and document your result.
  - a. Place Fold-a-View™ photo documentation hood on the blueGel™ electrophoresis system to take a picture with a smartphone or other digital camera.
  - b. Compare the bands from the DNA samples to the ladder to obtain size estimates and interpret the result (check “Expected results” section).

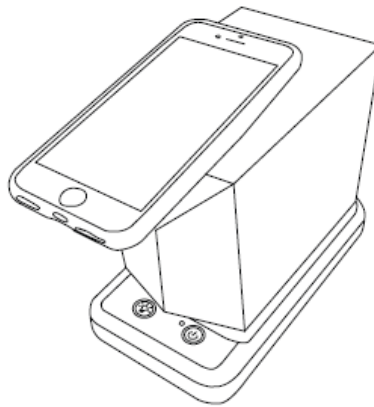

# Recessive White Chicken DNA Test

## EXPECTED RESULTS

- The negative control should show no bands. Bands appearing in the negative control signal contamination, invalidating the results of the experiment.
- Homozygotes individuals carrying two copies of the Recessive White allele ( $C^*C/C^*C$ ) will show one band at ~350 bp
- Heterozygotes individuals carrying one copy of the Recessive White allele ( $C^*C/C^*N$ ) will show two bands: one band at ~350 bp and the other at ~480 bp
- Wild type individuals ( $C^*N/C^*N$ ) will show only one band at ~480 bp
- gelPCR Control 1 will yield a band at ~900 bp

## EXAMPLE RESULTS

Lane 1: Ladder

Lane 2: Negative control (no DNA)

Lane 3, 4: Known wild-type ( $C^*N/C^*N$ )

Lane 5-6: Known heterozygotes Recessive White ( $C^*C/C^*N$ )

Lane 7-8: Known homozygotes Recessive White ( $C^*C/C^*C$ )

Lane 9: gelPCR Control 1

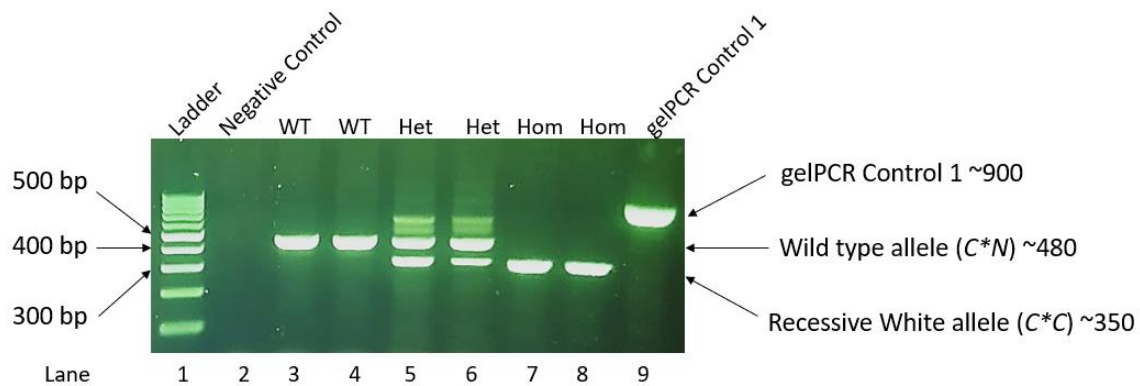

Questions? Email [dx@minipcr.com](mailto:dx@minipcr.com) or call +1-781-990-8727 for technical support.